

# LE FORATE

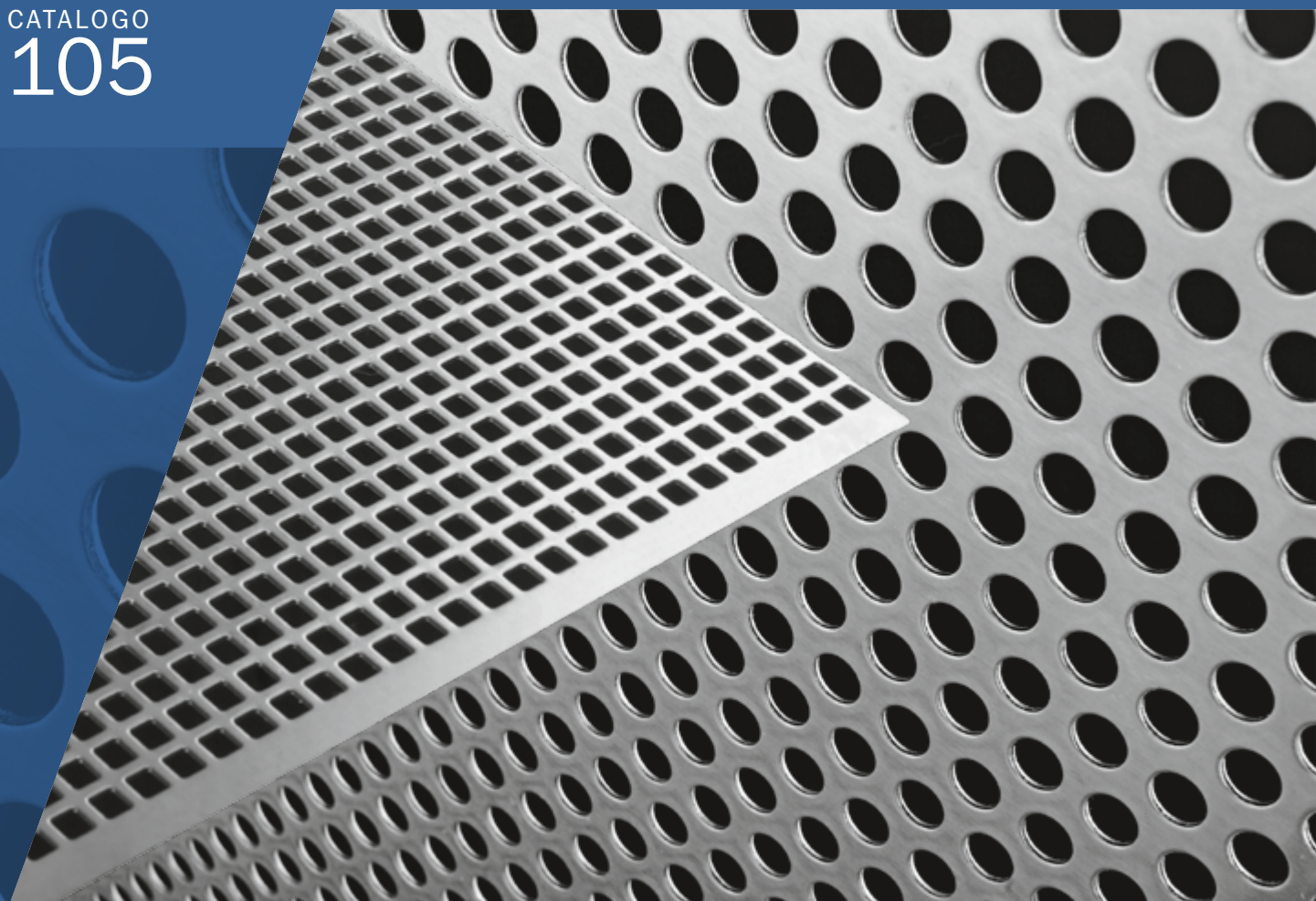

## LAMIERE FORATE A MAGAZZINO DAL PRONTO

CATALOGO  
**105**



**OLTRE 500 CODICI IN CONTINUA EVOLUZIONE  
OLTRE 125.000 FOGLI DAL PRONTO**





# LE FORATE

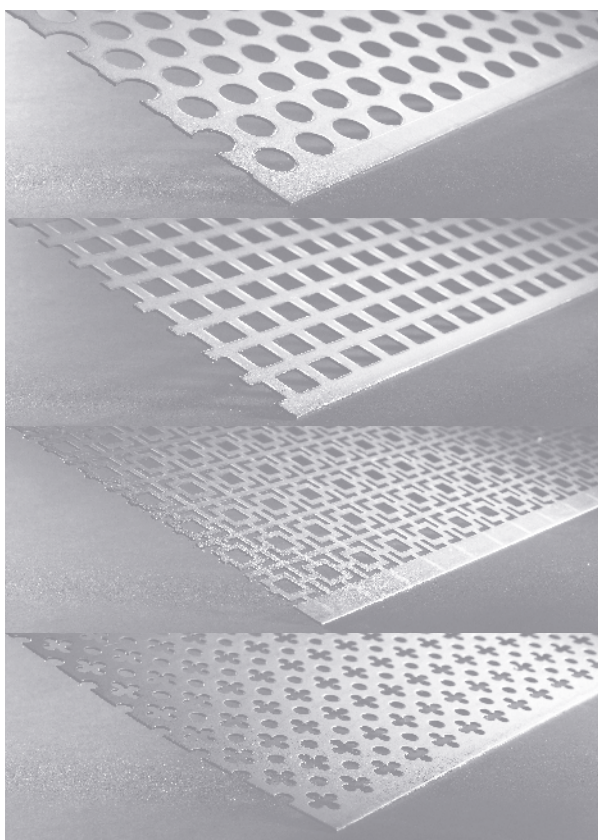



**LAMIERE FORATE PROVENIENTI  
DAI MIGLIORI PRODUTTORI  
DIRETTAMENTE NEI NOSTRI MAGAZZINI**

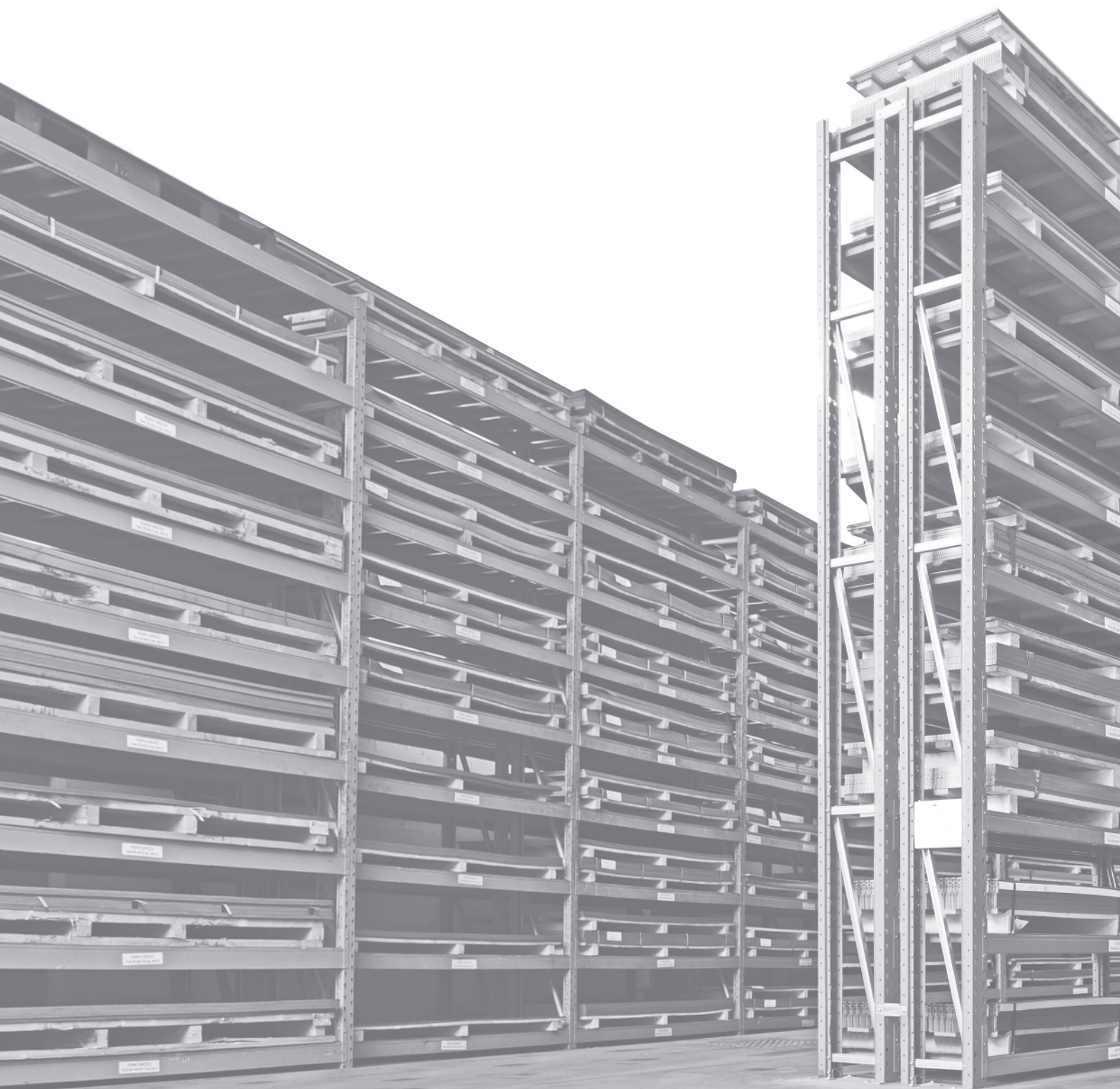

**QUANTITÀ DI ACQUISTO MINI**



**OLTRE 500 CODICI  
IN CONTINUA EVOLUZIONE  
PIÙ DI 125.000 FOGLI A STOCK**



**ME "ANCHE UN SOLO FOGLIO"**

# LE FORATE

## **Una scelta semplice e rapida.**

Con questa pubblicazione dedicata alle lamiere forate.

## **Vasta gamma.**

Centinaia di codici di lamiere forate tonde, quadre e fantasia.

**Diversi spessori e formati in vari materiali a scorta pronti per l'impiego.**

## **Richiedete i nostri prezzi.**

Risparmiate tempo con i nostri comodi servizi.

Servizio rapido di consegna.

## **Fils ti da di più.**

**Anche con la lamiera forata.**

## CARATTERISTICHE DEI FORMATI

LL - Bordi lati lunghi minimi

LC - Bordi lati corti frastagliati

*Dimensioni in mm*

Bordi pieni perimetrali a richiesta

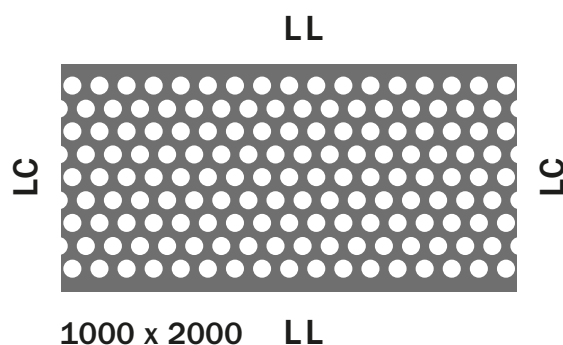

## MATERIALI DISPONIBILI

Acciaio al carbonio

Acciaio al carbonio Sendzimir

Acciaio INOX AISI 304

Acciaio INOX AISI 316

Alluminio

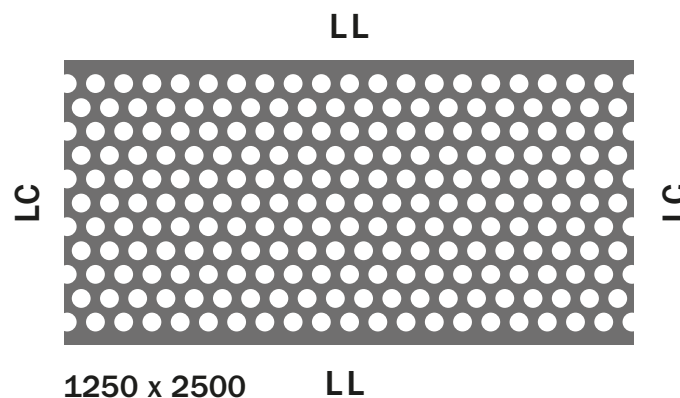

V/P = % vuoto/pieno

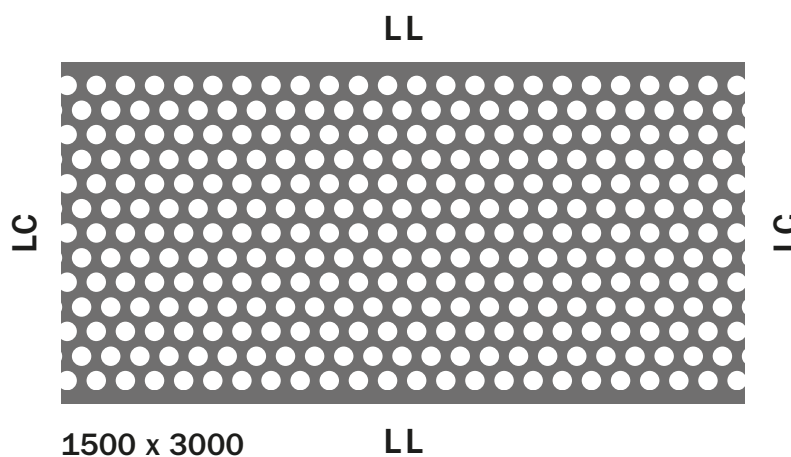

**I pesi e le percentuali vuoto/pieno sono indicativi**

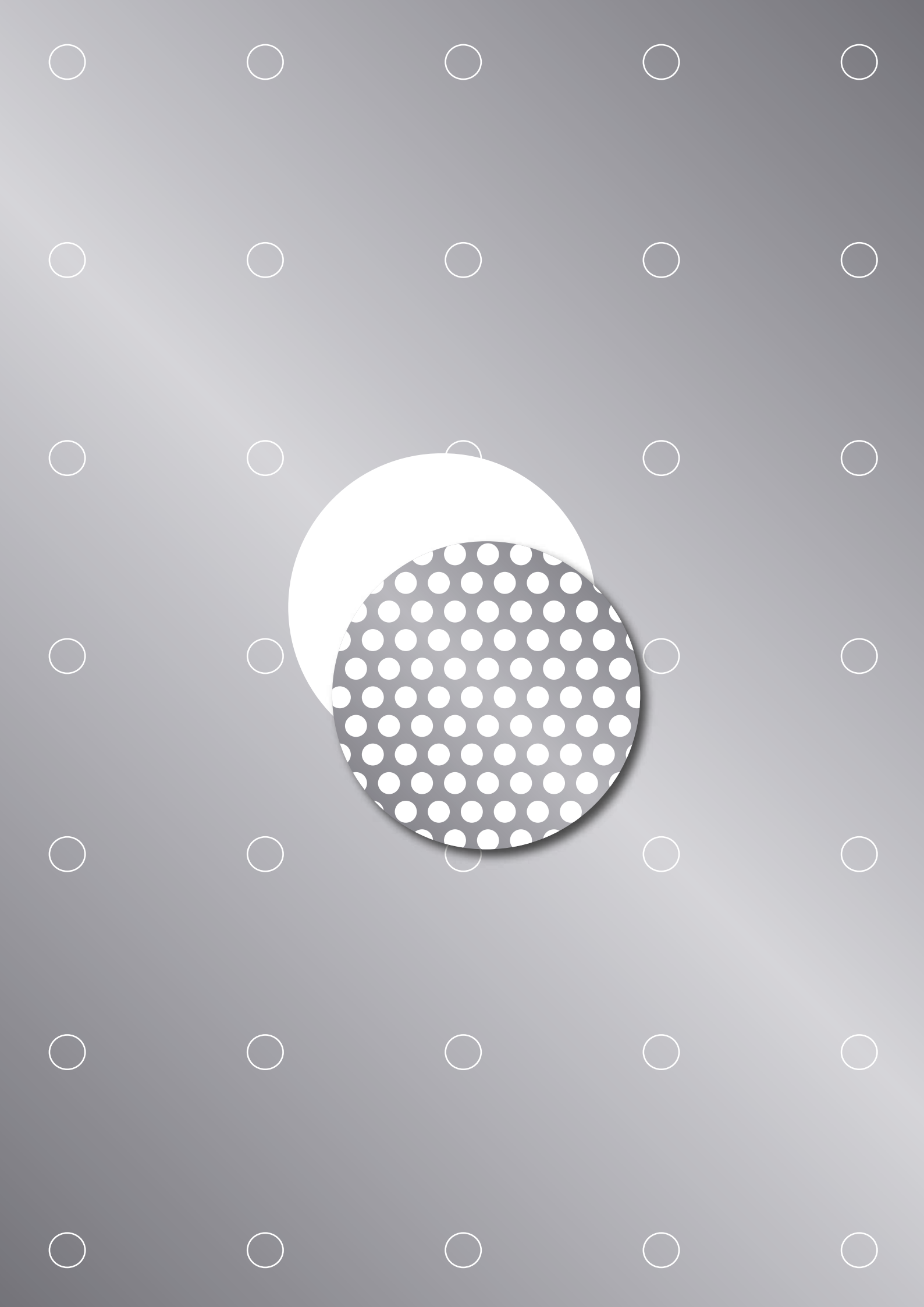



## FORI TONDI ALTERNATI A 60° "A QUINCONCE" (R)

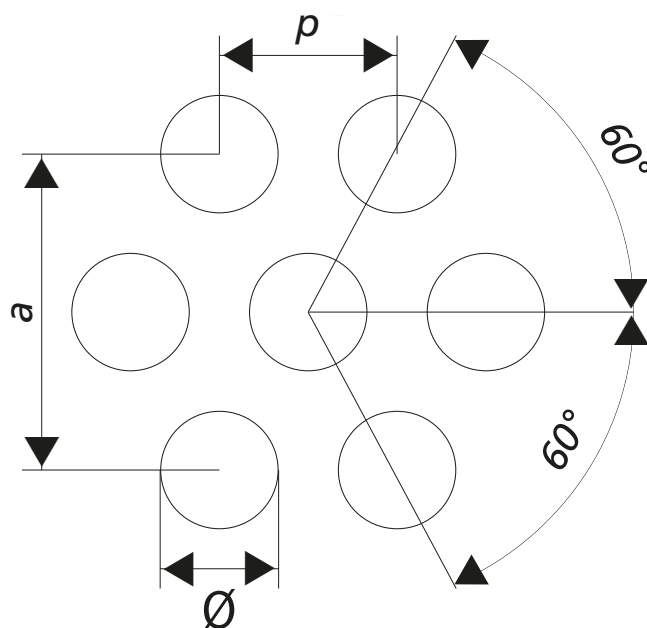

### Legenda

$\emptyset$  = diametro  
 $p$  = interasse  
 $a = p \sqrt{3}$   
 $s$  = superficie

### Superficie di passaggio

$$s (\%) = 90,6 \left( \frac{\emptyset}{p} \right)^2$$

### Esempio R 8

$\emptyset = 8 \text{ mm}$   
 $p = 12 \text{ mm}$

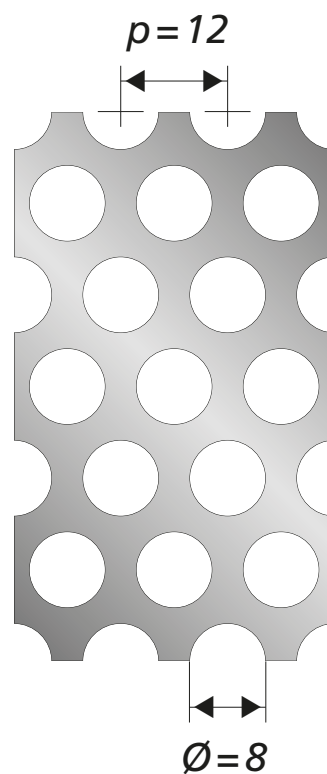

**R 1****Ø 1,0 mm - v/p 22,7%****MATERIALI****SPESSORE****FORMATO****ACCIAIO  
AL CARBONIO**

mm

**1000 X 2000**

Peso Kg/cad.

1,0

12,10

**ACCIAIO  
INOX AISI 304**

mm

**1000 X 2000**

Peso Kg/cad.

1,0

12,10

**R 1,5****Ø 1,5 mm - v/p 22,7%****MATERIALI****SPESSORE****FORMATO****ACCIAIO  
AL CARBONIO**

mm

**1000 X 2000**

Peso Kg/cad.

1,0

12,10

1,5

18,00

**ACCIAIO  
INOX AISI 304**

mm

**1000 X 2000**

Peso Kg/cad.

1,0

12,10

1,5

18,00

R 2

Ø 2,0 mm - v/p 29,6%

MATERIALI	SPESSORE	FORMATO	FORMATO	FORMATO
ACCIAIO AL CARBONIO	mm	1000 X 2000 Peso Kg/cad.	1250 X 2000 Peso Kg/cad.	1500 X 3000 Peso Kg/cad.
	1,0	11,00	17,00	24,90
	1,5	16,60	26,00	41,00
	2,0	24,30	38,00	54,60
ACCIAIO INOX AISI 304	mm	1000 X 2000 Peso Kg/cad.	1250 X 2500 Peso Kg/cad.	1500 X 3000 Peso Kg/cad.
	1,0	11,00		
	1,5	16,60	29,00	41,80
	2,0	24,30		

R 2,5

Ø 2,5 mm - v/p 35,4%

MATERIALI	SPESSORE	FORMATO
ACCIAIO AL CARBONIO	mm	1000 X 2000 Peso Kg/cad.
	1,0	10,20
	1,5	15,30
	2,0	20,30



R 3

Ø 3,0 mm - v/p 32,6%

MATERIALI	SPESSORE	FORMATO	FORMATO	FORMATO
<b>ACCIAIO AL CARBONIO</b>	mm	1000 X 2000 Peso Kg/cad.	1250 X 2500 Peso Kg/cad.	1500 X 3000 Peso Kg/cad.
	0,8	8,80		
	1,0	10,60	16,50	24,30
	1,5	15,90	24,80	35,70
	2,0	21,20	33,00	48,00
	3,0	31,70	49,60	71,00
<b>ACCIAIO AL CARBONIO SENDZIMIR</b>	mm	1000 X 2000 Peso Kg/cad.	1250 X 2500 Peso Kg/cad.	1500 X 3000 Peso Kg/cad.
	0,8	8,80		
	1,0	10,60	16,50	24,30
	1,5	15,90	24,80	35,70
	2,0	21,20	33,00	48,00
	3,0	32,00	49,60	71,00
<b>ACCIAIO AL INOX AISI 304</b>	mm	1000 X 2000 Peso Kg/cad.	1250 X 2500 Peso Kg/cad.	1500 X 3000 Peso Kg/cad.
	0,8	8,60		
	1,0	10,60		
	1,5	15,90	24,80	35,70
	2,0	21,20	33,70	48,50
<b>ACCIAIO INOX AISI 316</b>	mm	1000 X 2000 Peso Kg/cad.	1250 X 2500 Peso Kg/cad.	1500 X 3000 Peso Kg/cad.
	1,0	10,60		
	1,5	16,20	25,30	36,40
	2,0	21,60		
<b>ALLUMINIO</b>	mm	1000 X 2000 Peso Kg/cad.	1250 X 2500 Peso Kg/cad.	1500 X 3000 Peso Kg/cad.
	1,0	3,60	5,69	8,20
	1,5	5,60	8,40	12,30
	2,0	7,30	11,40	16,40
	3,0	10,90		

R 4

Ø 4,0 mm - v/p 40,3%

MATERIALI	SPESSORE	FORMATO	FORMATO	FORMATO
<b>ACCIAIO AL CARBONIO</b>	mm	1000 X 2000 Peso Kg/cad.	1250 X 2500 Peso Kg/cad.	1500 X 3000 Peso Kg/cad.
	0,8	7,50		
	1,0	9,40	14,60	21,50
	1,5	14,00	22,00	32,00
	2,0	18,70	29,30	42,10
	3,0	33,20	51,80	74,60
<b>ACCIAIO AL CARBONIO SENDZIMIR</b>	mm	1000 X 2000 Peso Kg/cad.	1250 X 2500 Peso Kg/cad.	1500 X 3000 Peso Kg/cad.
	0,8	7,50		
	1,0	9,40	14,60	21,50
	1,5	14,00	22,00	32,20
	2,0	18,70	29,30	42,10
	3,0	33,20	51,80	74,60
<b>ACCIAIO AL INOX AISI 304</b>	mm	1000 X 2000 Peso Kg/cad.	1250 X 2500 Peso Kg/cad.	1500 X 3000 Peso Kg/cad.
	0,8	7,60		
	1,0	9,40		
	1,5	14,00	22,40	32,30
	2,0	18,70	35,20	51,00
<b>ACCIAIO INOX AISI 316</b>	mm	1000 X 2000 Peso Kg/cad.	1250 X 2500 Peso Kg/cad.	1500 X 3000 Peso Kg/cad.
	1,0	9,40		
	1,5	14,00	22,40	32,30
	2,0	18,70		
<b>ALLUMINIO</b>	mm	1000 X 2000 Peso Kg/cad.	1250 X 2500 Peso Kg/cad.	1500 X 3000 Peso Kg/cad.
	1,0	3,10	5,00	7,20
	1,5	5,00	7,60	10,88
	2,0	6,50	10,10	14,50
	3,0	9,70		

R 5

Ø 5,0 mm - v/p 35,4%

MATERIALI	SPESSORE	FORMATO	FORMATO	FORMATO
<b>ACCIAIO AL CARBONIO</b>	mm	1000 X 2000 Peso Kg/cad.	1250 X 2500 Peso Kg/cad.	1500 X 3000 Peso Kg/cad.
	0,8	8,10		
	1,0	10,20	15,80	23,30
	1,5	15,30	23,80	34,50
	2,0	20,30	31,70	45,60
	3,0	30,50	47,50	68,50
	4,0	49,50		
	5,0	61,90		
<b>ACCIAIO AL CARBONIO SENDZIMIR</b>	mm	1000 X 2000 Peso Kg/cad.	1250 X 2500 Peso Kg/cad.	1500 X 3000 Peso Kg/cad.
	0,8	8,10		
	1,0	10,20	15,80	23,30
	1,5	15,30	23,80	34,50
	2,0	20,30	31,70	45,60
	3,0	30,40	47,50	68,50
<b>ACCIAIO AL INOX AISI 304</b>	mm	1000 X 2000 Peso Kg/cad.	1250 X 2500 Peso Kg/cad.	1500 X 3000 Peso Kg/cad.
	0,8	8,30		
	1,0	10,20		
	1,5	15,30	23,80	34,50
	2,0	20,30	32,30	46,50
	3,0	30,50		
<b>ACCIAIO INOX AISI 316</b>	mm	1000 X 2000 Peso Kg/cad.	1250 X 2500 Peso Kg/cad.	1500 X 3000 Peso Kg/cad.
	1,0	10,40		
	1,5	15,30	24,20	34,90
	2,0	20,30		
<b>ALLUMINIO</b>	mm	1000 X 2000 Peso Kg/cad.	1250 X 2500 Peso Kg/cad.	1500 X 3000 Peso Kg/cad.
	1,0	3,50	5,50	7,90
	1,5	4,40	8,20	11,80
	2,0	6,92	10,90	15,70
	3,0	10,50		



R 6

Ø 6,0 mm - v/p 40,3%

MATERIALI	SPESSORE	FORMATO	FORMATO	FORMATO
<b>ACCIAIO AL CARBONIO</b>	mm	1000 X 2000 Peso Kg/cad.	1250 X 2500 Peso Kg/cad.	1500 X 3000 Peso Kg/cad.
	0,8	7,50		
	1,0	9,40	14,60	21,50
	1,5	14,00	19,80	29,30
	2,0	18,80	29,30	42,00
	3,0	28,20	44,80	63,30
	4,0	43,10		
	5,0	53,90		
<b>ACCIAIO AL CARBONIO SENDZIMIR</b>	mm	1000 X 2000 Peso Kg/cad.	1250 X 2500 Peso Kg/cad.	1500 X 3000 Peso Kg/cad.
	0,8	7,50		
	1,0	9,40	14,60	21,50
	1,5	14,00	19,80	29,30
	2,0	18,80	29,30	42,00
	3,0	28,10	44,80	63,30
<b>ACCIAIO AL INOX AISI 304</b>	mm	1000 X 2000 Peso Kg/cad.	1250 X 2500 Peso Kg/cad.	1500 X 3000 Peso Kg/cad.
	0,8	7,60		
	1,0	9,40		
	1,5	14,00	22,40	32,20
	2,0	18,80	28,50	43,00
	3,0	28,20		
<b>ACCIAIO INOX AISI 316</b>	mm	1000 X 2000 Peso Kg/cad.	1250 X 2500 Peso Kg/cad.	1500 X 3000 Peso Kg/cad.
	1,0	9,50		
	1,5	14,30	22,40	32,20
	2,0	18,80		
<b>ALLUMINIO</b>	mm	1000 X 2000 Peso Kg/cad.	1250 X 2500 Peso Kg/cad.	1500 X 3000 Peso Kg/cad.
	1,0	3,20	5,00	7,20
	1,5	5,00	7,60	11,00
	2,0	6,50	10,00	14,50
	3,0	9,70		

R 8

Ø 8,0 mm - v/p 40,3%

MATERIALI	SPESSORE	FORMATO	FORMATO	FORMATO
<b>ACCIAIO AL CARBONIO</b>	mm	1000 X 2000 Peso Kg/cad.	1250 X 2500 Peso Kg/cad.	1500 X 3000 Peso Kg/cad.
	0,8	7,50		
	1,0	9,40	14,60	21,50
	1,5	14,00	22,00	31,60
	2,0	18,80	29,30	42,20
	3,0	28,20	43,90	63,30
	4,0	38,20		
	5,0	47,80		
<b>ACCIAIO AL CARBONIO SENDZIMIR</b>	mm	1000 X 2000 Peso Kg/cad.	1250 X 2500 Peso Kg/cad.	1500 X 3000 Peso Kg/cad.
	0,8	7,50		
	1,0	9,40	14,60	21,50
	1,5	14,00	22,00	31,60
	2,0	18,60	29,30	42,20
	3,0	28,10	44,00	63,30
<b>ACCIAIO AL INOX AISI 304</b>	mm	1000 X 2000 Peso Kg/cad.	1250 X 2500 Peso Kg/cad.	1500 X 3000 Peso Kg/cad.
	0,8	7,60		
	1,0	9,40		
	1,5	14,00	22,00	31,60
	2,0	18,80	29,90	43,00
	3,0	28,20		
<b>ACCIAIO INOX AISI 316</b>	mm	1000 X 2000 Peso Kg/cad.	1250 X 2500 Peso Kg/cad.	1500 X 3000 Peso Kg/cad.
	1,0	9,60		
	1,5	14,30	22,40	32,20
	2,0	19,10		
<b>ALLUMINIO</b>	mm	1000 X 2000 Peso Kg/cad.	1250 X 2500 Peso Kg/cad.	1500 X 3000 Peso Kg/cad.
	1,0	3,20	5,00	7,30
	1,5	5,00	7,60	10,90
	2,0	6,50	10,70	14,50
	3,0	9,70		

R 10

Ø 10,0 mm - v/p 40,3%

MATERIALI	SPESSORE	FORMATO	FORMATO	FORMATO
<b>ACCIAIO AL CARBONIO</b>	mm	1000 X 2000 Peso Kg/cad.	1250 X 2500 Peso Kg/cad.	1500 X 3000 Peso Kg/cad.
	0,8	7,50		
	1,0	9,40	14,60	21,50
	1,5	14,00	22,00	31,60
	2,0	18,80	29,30	42,20
	3,0	28,20	44,00	63,30
	4,0	38,20		
	5,0	47,80		
<b>ACCIAIO AL CARBONIO SENDZIMIR</b>	mm	1000 X 2000 Peso Kg/cad.	1250 X 2500 Peso Kg/cad.	1500 X 3000 Peso Kg/cad.
	0,8	7,50		
	1,0	9,40	14,60	21,50
	1,5	14,00	22,00	31,60
	2,0	18,80	29,30	42,20
	3,0	28,10	44,00	63,30
<b>ACCIAIO AL INOX AISI 304</b>	mm	1000 X 2000 Peso Kg/cad.	1250 X 2500 Peso Kg/cad.	1500 X 3000 Peso Kg/cad.
	0,8	7,60		
	1,0	9,40		
	1,5	14,00	22,00	31,60
	2,0	18,80	29,90	43,00
	3,0	28,20		
<b>ACCIAIO INOX AISI 316</b>	mm	1000 X 2000 Peso Kg/cad.	1250 X 2500 Peso Kg/cad.	1500 X 3000 Peso Kg/cad.
	1,0	9,50		
	1,5	14,30	22,40	32,20
	2,0	19,10		
<b>ALLUMINIO</b>	mm	1000 X 2000 Peso Kg/cad.	1250 X 2500 Peso Kg/cad.	1500 X 3000 Peso Kg/cad.
	1,0	3,10	5,00	7,30
	1,5	5,00	7,60	10,90
	2,0	6,30	10,10	14,50
	3,0	9,70		



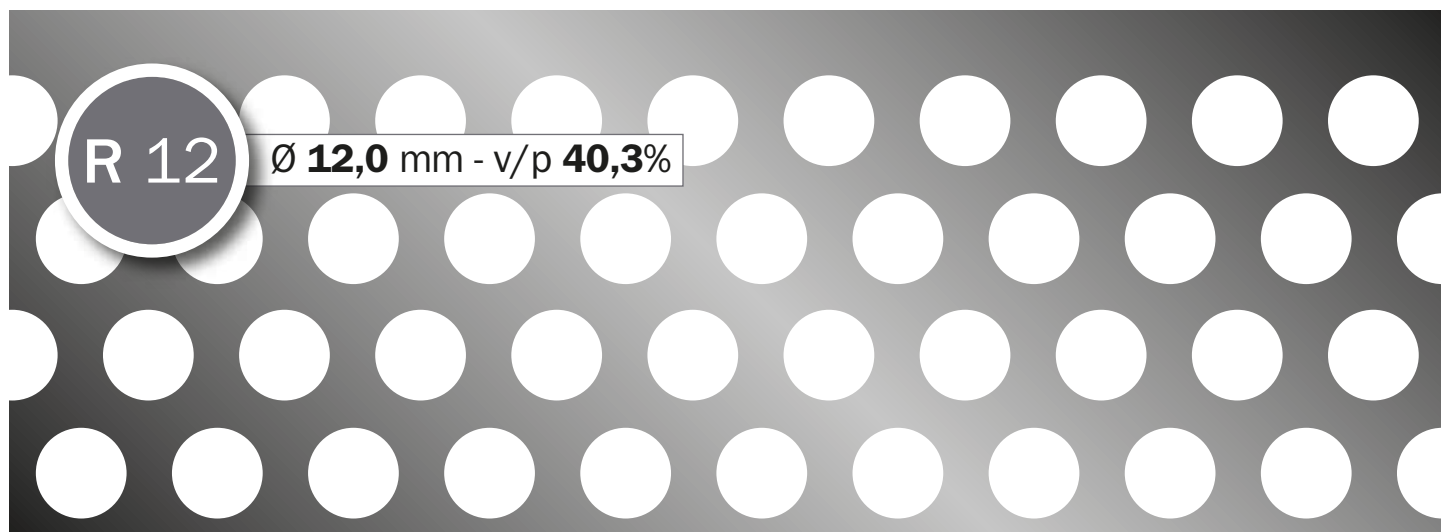

MATERIALI	SPESSORE	FORMATO	FORMATO	FORMATO
ACCIAIO AL CARBONIO	mm	1000 X 2000 Peso Kg/cad.	1250 X 2500 Peso Kg/cad.	1500 X 3000 Peso Kg/cad.
	1,0	9,40	14,60	21,10
	1,5	14,00	22,00	31,60
	2,0	19,00	29,30	42,20
	3,0	28,10	44,00	63,00

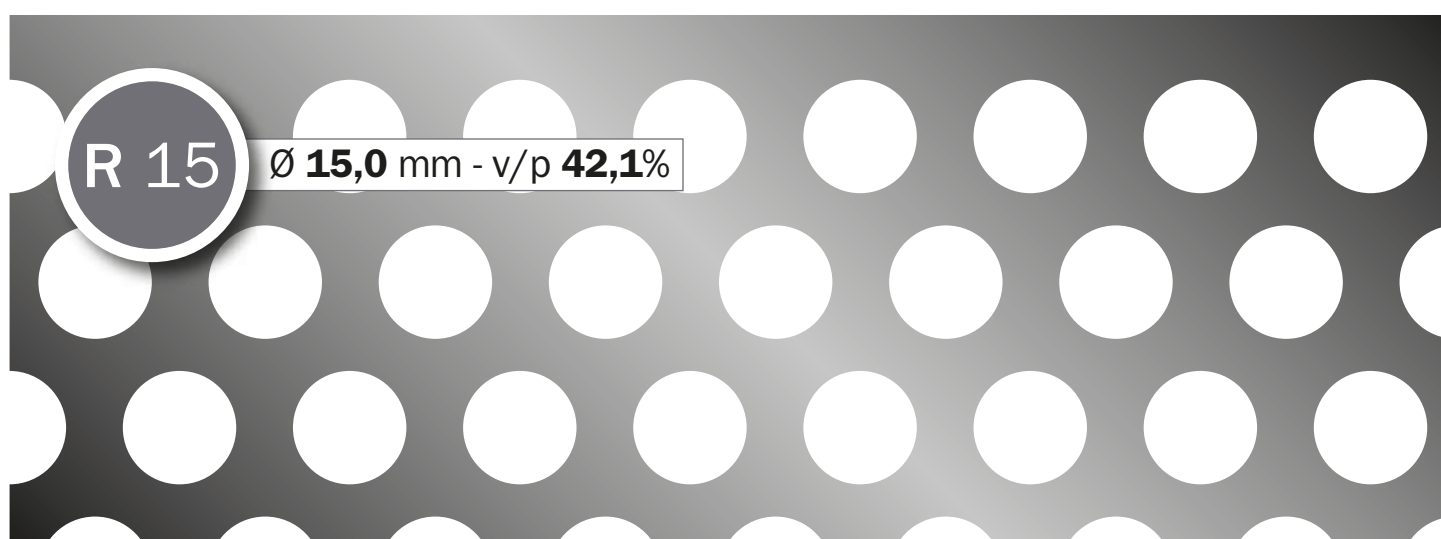

MATERIALI	SPESSORE	FORMATO	FORMATO	FORMATO
ACCIAIO AL CARBONIO	mm	1000 X 2000 Peso Kg/cad.	1250 X 2500 Peso Kg/cad.	1500 X 3000 Peso Kg/cad.
	1,5	11,00	20,00	23,80
	2,0	18,20	28,30	33,20
	3,0	27,00	36,40	62,00

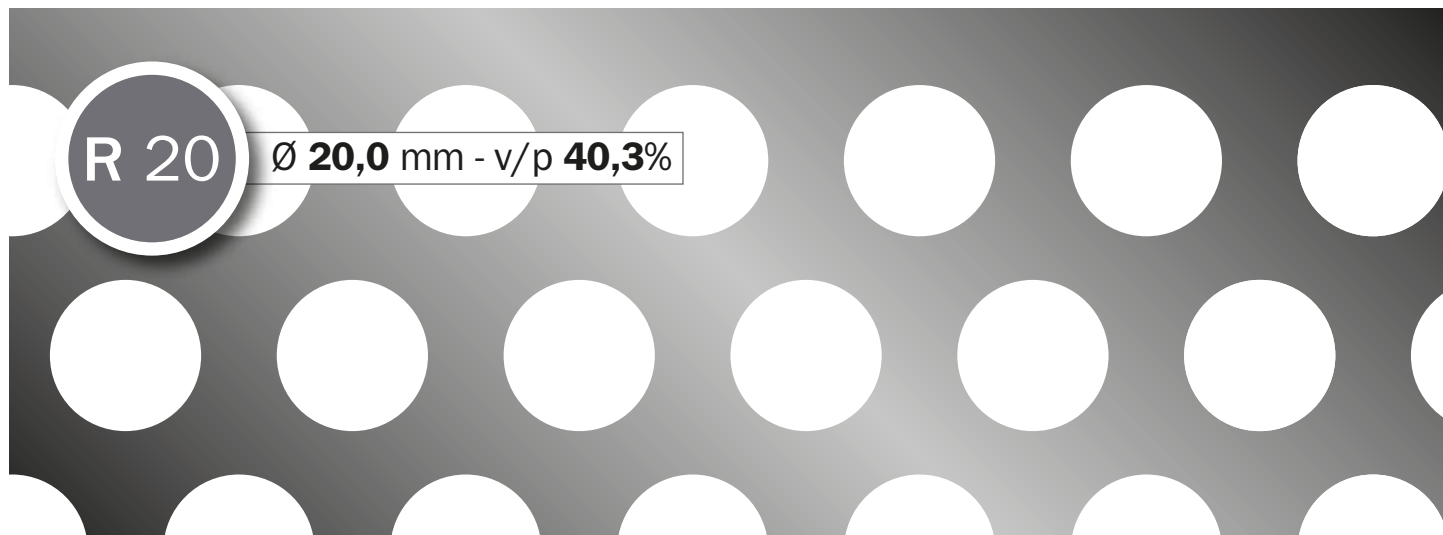

MATERIALI	SPESSORE	FORMATO	FORMATO	FORMATO
ACCIAIO AL CARBONIO	mm	1000 X 2000 Peso Kg/cad.	1250 X 2500 Peso Kg/cad.	1500 X 3000 Peso Kg/cad.
	1,5	12,00	19,00	26,70
	2,0	17,90	25,00	35,60
	3,0	28,10	38,00	56,20

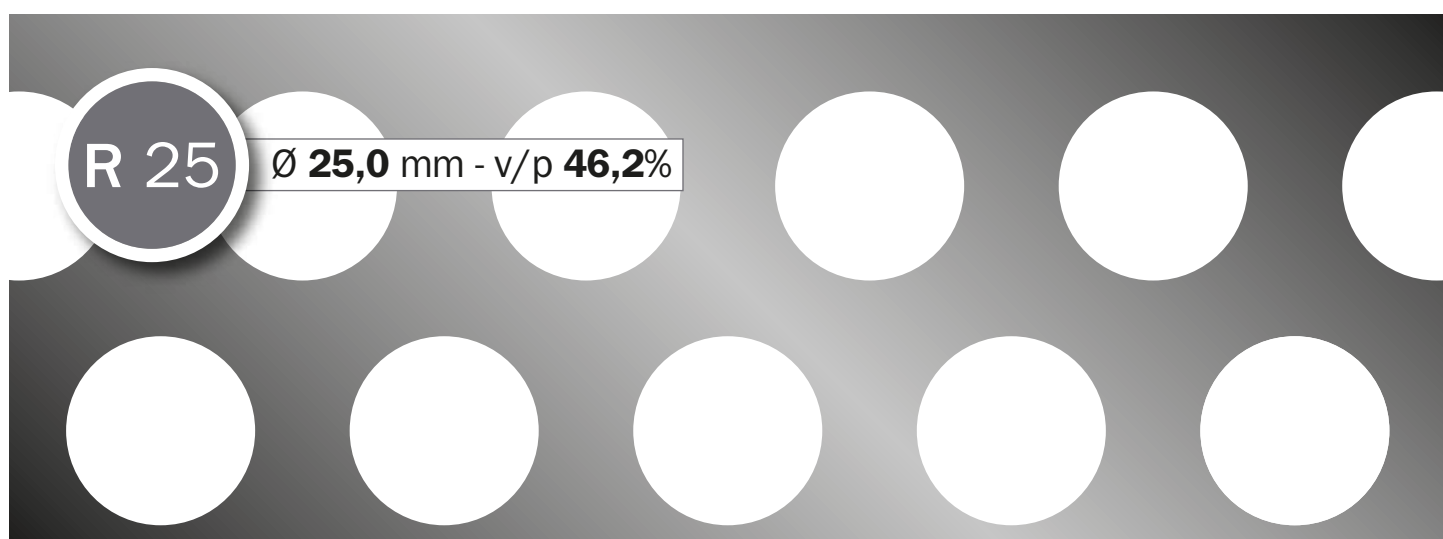

MATERIALI	SPESSORE	FORMATO	FORMATO	FORMATO
ACCIAIO AL CARBONIO	mm	1000 X 2000 Peso Kg/cad.	1250 X 2500 Peso Kg/cad.	1500 X 3000 Peso Kg/cad.
	1,5		19,00	31,00
	2,0	14,00	26,40	38,00
	3,0		40,50	59,00

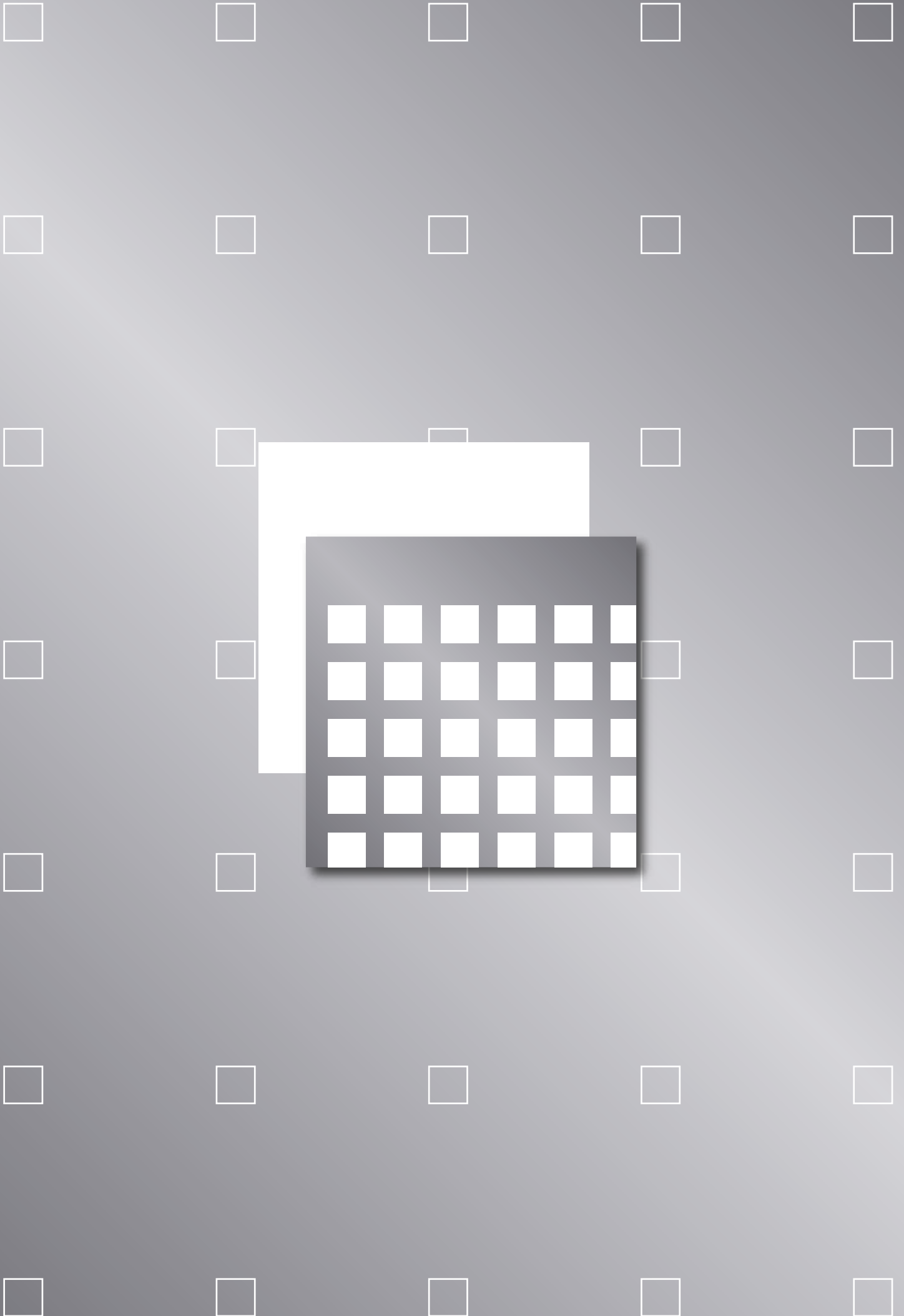



## FORI QUADRI PARI "IN LINEA" (C - U)

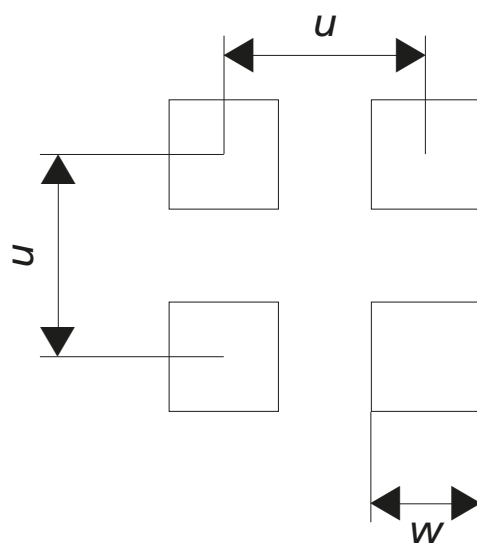

### Legenda

w = lato

u = interasse

s = superficie

### Superficie di passaggio

$$s (\%) = 100 \left( \frac{w}{u} \right)^2$$

### Esempio C 8 - U12

#### Norma ISO

w = 8 mm

u = 12 mm

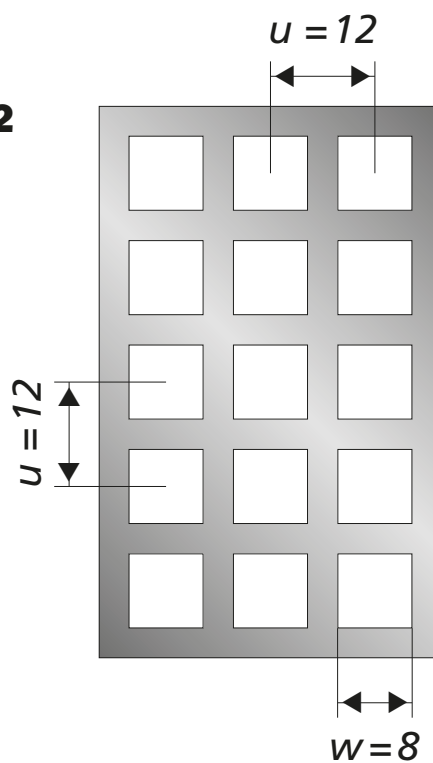



C 5  
U 7

C (w) 5,0 mm - v/p 51,0%

MATERIALI	U	SPESSORE	FORMATO
<b>ACCIAIO AL CARBONIO</b>	mm	mm	1000 X 2000 Peso Kg/cad.
	7,0	1,0	7,70
	7,0	1,5	11,60
<b>ACCIAIO AL CARBONIO SENDZIMIR</b>	mm	mm	1000 X 2000 Peso Kg/cad.
	7,0	1,5	11,60
<b>ACCIAIO AL INOX AISI 304</b>	mm	mm	1000 X 2000 Peso Kg/cad.
	7,0	1,0	7,70
<b>ALLUMINIO</b>	mm	mm	1000 X 2000 Peso Kg/cad.
	7,0	1,0	2,60

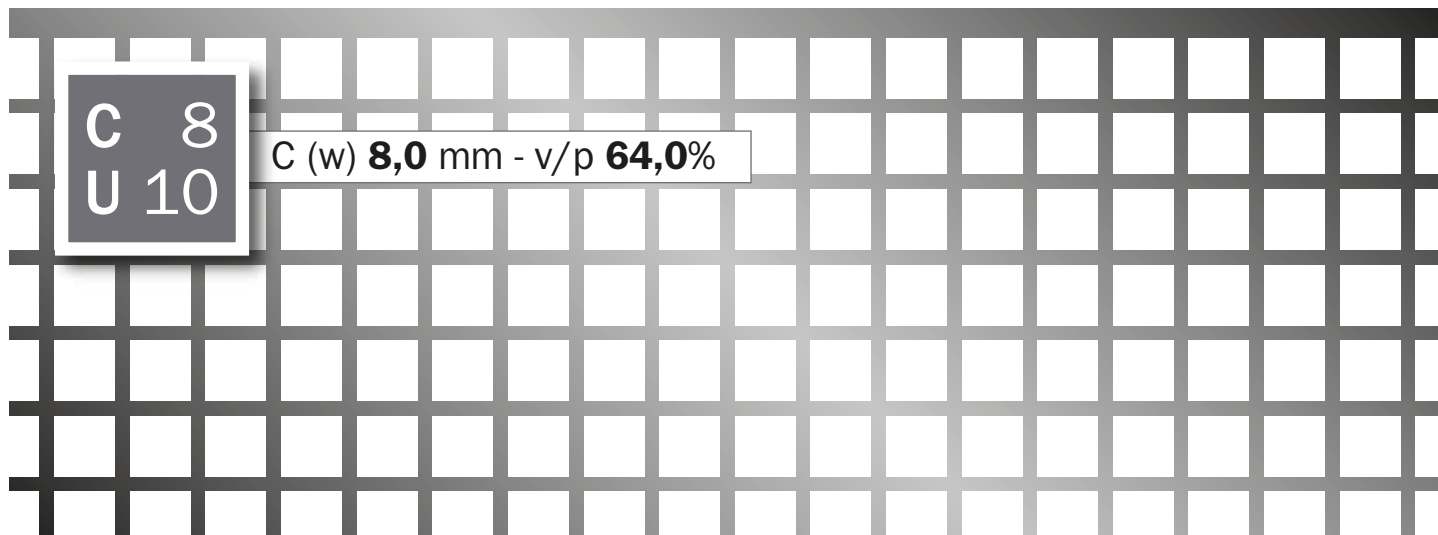

MATERIALI	U	SPESSORE	FORMATO
ACCIAIO AL CARBONIO			1000 X 2000
	mm	mm	Peso Kg/cad.
	10,0	1,0	5,70
	10,0	1,5	8,50

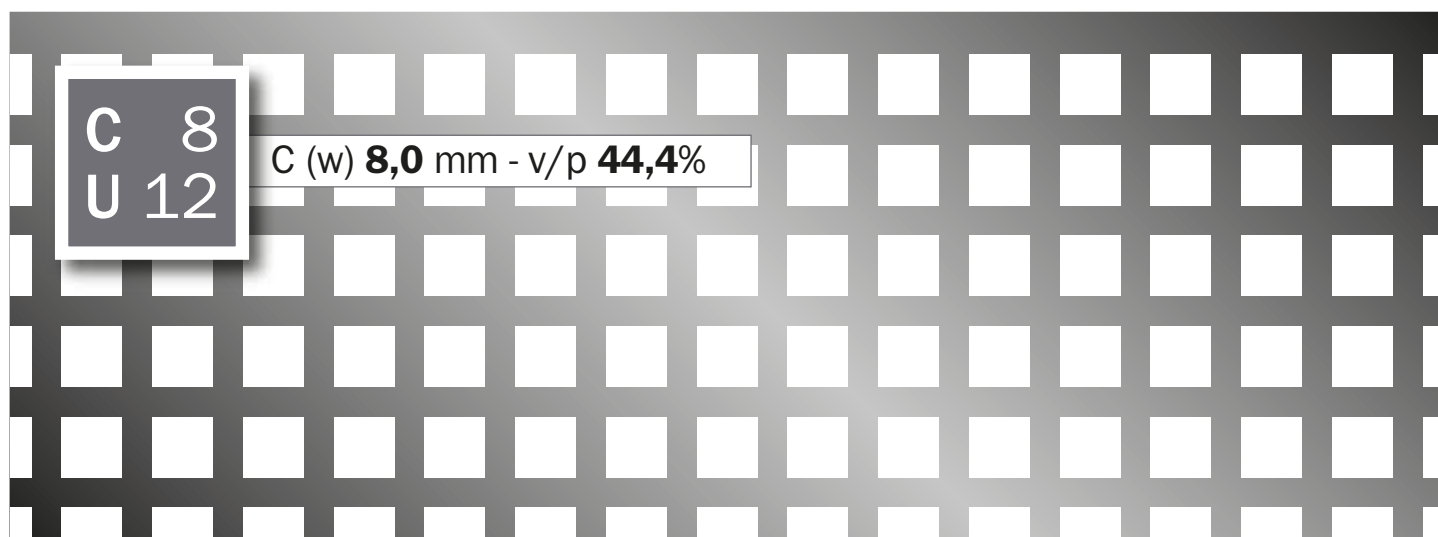

MATERIALI	U	SPESSORE	FORMATO	FORMATO	FORMATO
ACCIAIO AL CARBONIO			1000 X 2000	1250 X 2500	1500 X 3000
	mm	mm	Peso Kg/cad.	Peso Kg/cad.	Peso Kg/cad.
	12,0	1,0	8,80	13,60	19,60
	12,0	1,5	13,00	20,50	29,50
	12,0	2,0	17,50	27,30	39,00

ACCIAIO AL CARBONIO SENDZIMIR	U	SPESSORE	FORMATO	FORMATO	FORMATO
			1000 X 2000	1250 X 2500	1500 X 3000
	mm	mm	Peso Kg/cad.	Peso Kg/cad.	Peso Kg/cad.
	12,0	1,0		13,60	20,60
	12,0	1,5	13,00	20,40	29,50
	12,0	2,0		27,30	39,00

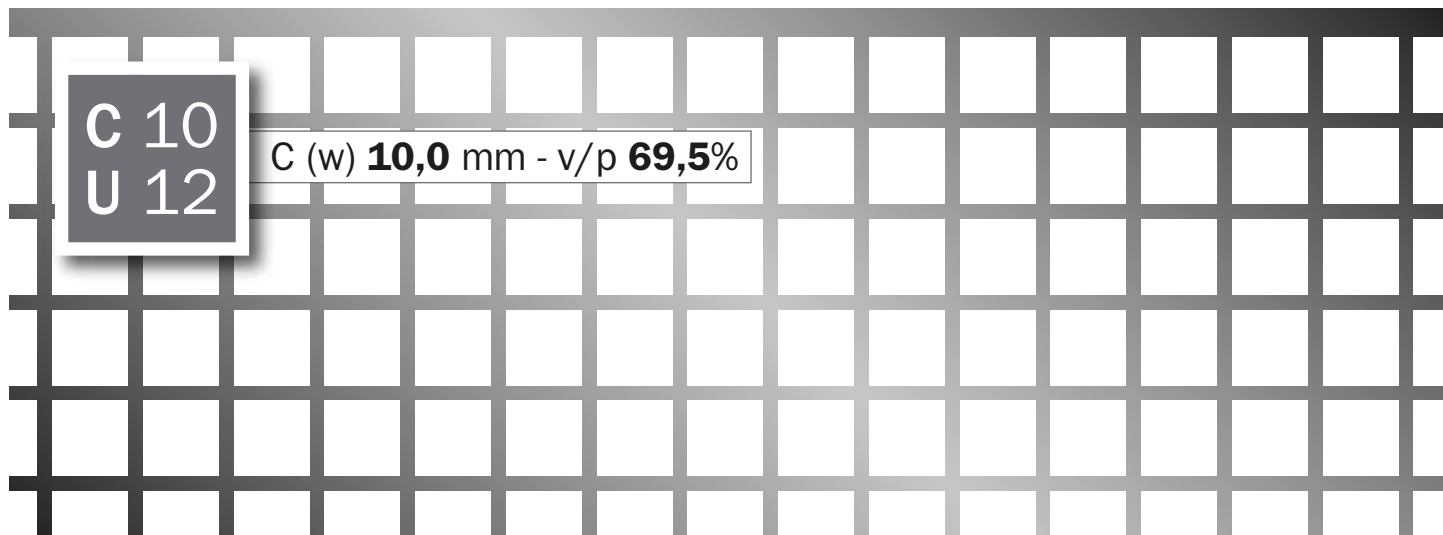

MATERIALI	U	SPESSORE	FORMATO
ACCIAIO AL CARBONIO	mm	mm	1000 X 2000 Peso Kg/cad.
	12,0	1,0	4,80
	12,0	1,5	7,10



C 10  
U 15

C (w) **10,0 mm** - v/p **44,4%**

MATERIALI	U	SPESSORE	FORMATO	FORMATO	FORMATO
<b>ACCIAIO AL CARBONIO</b>	mm	mm	1000 X 2000 Peso Kg/cad.	1250 X 2500 Peso Kg/cad.	1500 X 3000 Peso Kg/cad.
	15,0	0,8	7,00		
	15,0	1,0	8,70	13,60	20,00
	15,0	1,5	13,00	20,40	29,50
	15,0	2,0	17,50	27,30	39,00
	15,0	3,0	26,20	42,00	59,00
<b>ACCIAIO AL CARBONIO SENDZIMIR</b>	mm	mm	1000 X 2000 Peso Kg/cad.	1250 X 2500 Peso Kg/cad.	1500 X 3000 Peso Kg/cad.
	15,0	0,8	7,00		
	15,0	1,0	8,70	13,60	20,00
	15,0	1,5	13,00	20,40	29,50
	15,0	2,0	17,50	27,30	39,00
	15,0	3,0	26,20	42,00	59,00
<b>ACCIAIO INOX AISI 304</b>	mm	mm	1000 X 2000 Peso Kg/cad.	1250 X 2500 Peso Kg/cad.	1500 X 3000 Peso Kg/cad.
	15,0	0,8	7,00		
	15,0	1,0	8,70	13,90	20,00
	15,0	1,5	13,00	20,40	29,50
	15,0	2,0	17,80	29,90	40,00
<b>ACCIAIO AL INOX AISI 316</b>	mm	mm	1000 X 2000 Peso Kg/cad.	1250 X 2500 Peso Kg/cad.	1500 X 3000 Peso Kg/cad.
	15,0	1,0	8,90		
	15,0	1,5	13,30		
	15,0	2,0	17,80		
<b>ALLUMINIO</b>	mm	mm	1000 X 2000 Peso Kg/cad.	1250 X 2500 Peso Kg/cad.	1500 X 3000 Peso Kg/cad.
	15,0	1,0	3,00	4,70	6,80
	15,0	1,5	4,60	7,00	10,10
	15,0	2,0	6,00	9,10	13,50
	15,0	3,0	9,00		



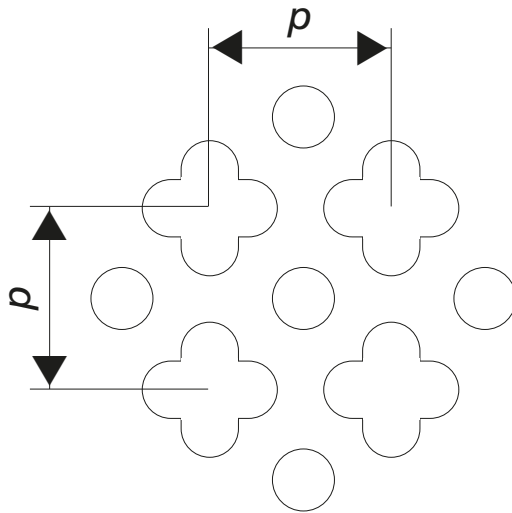

**Legenda**

$p$  = interasse

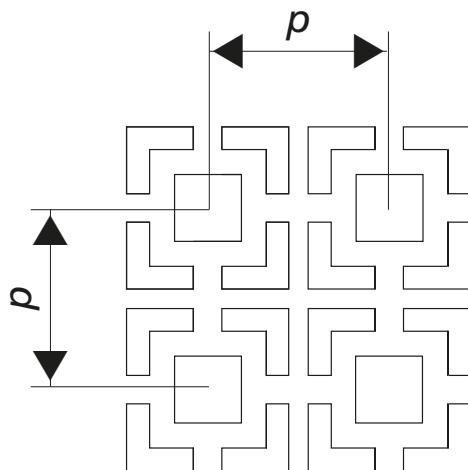

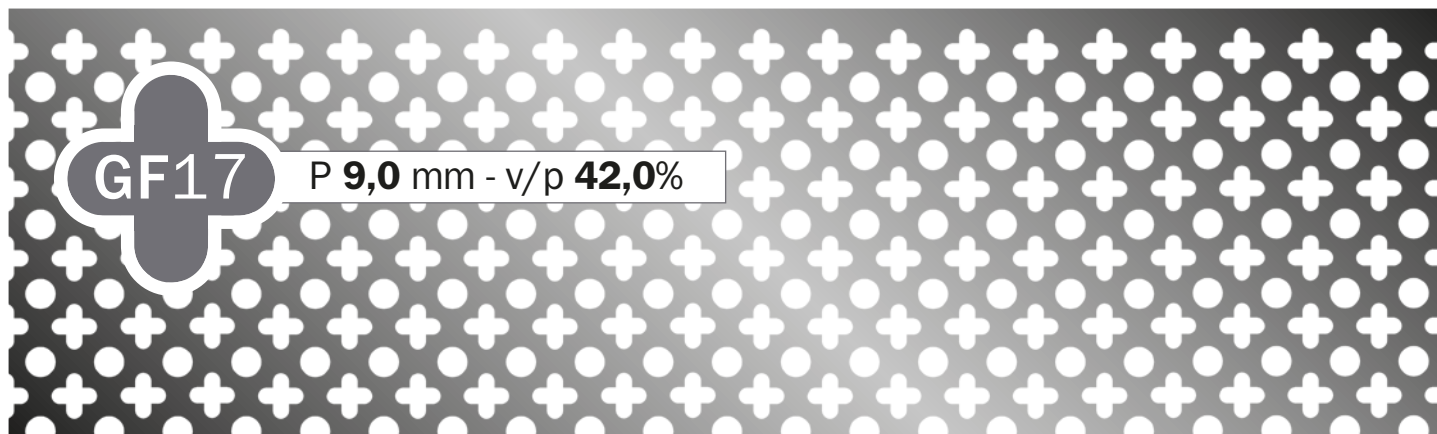

MATERIALI	P	SPESSORE	FORMATO
ACCIAIO AL CARBONIO	mm	mm	1000 X 2000 Peso Kg/cad.
	9,0	1,0	8,80

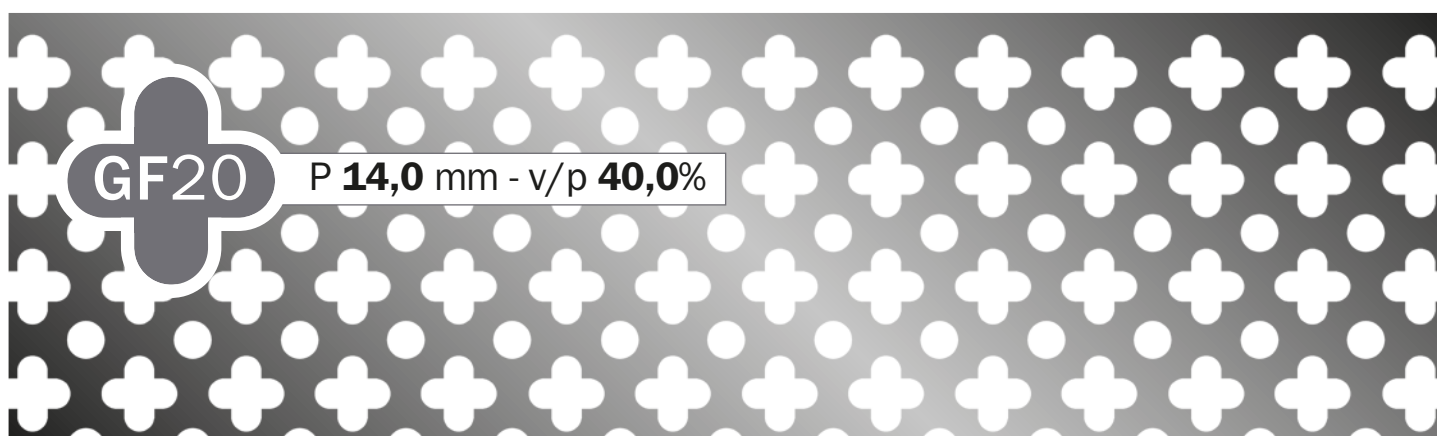

MATERIALI	P	SPESSORE	FORMATO
ACCIAIO AL CARBONIO	mm	mm	1000 X 2000 Peso Kg/cad.
	14,0	1,0	11,30

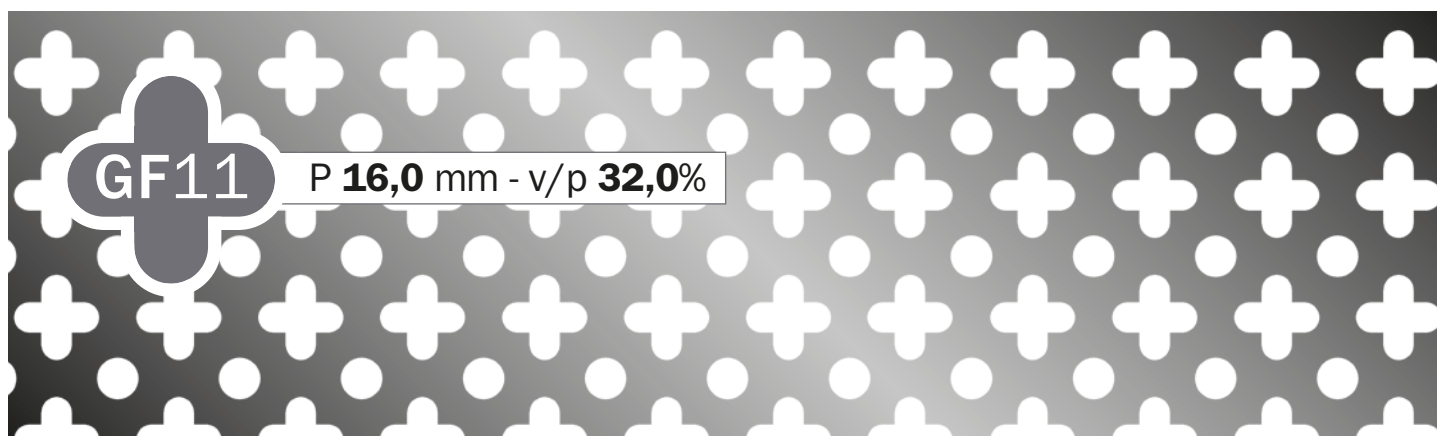

MATERIALI	P	SPESSORE	FORMATO
ACCIAIO AL CARBONIO	mm	mm	1000 X 2000 Peso Kg/cad.
	16,0	1,0	7,00



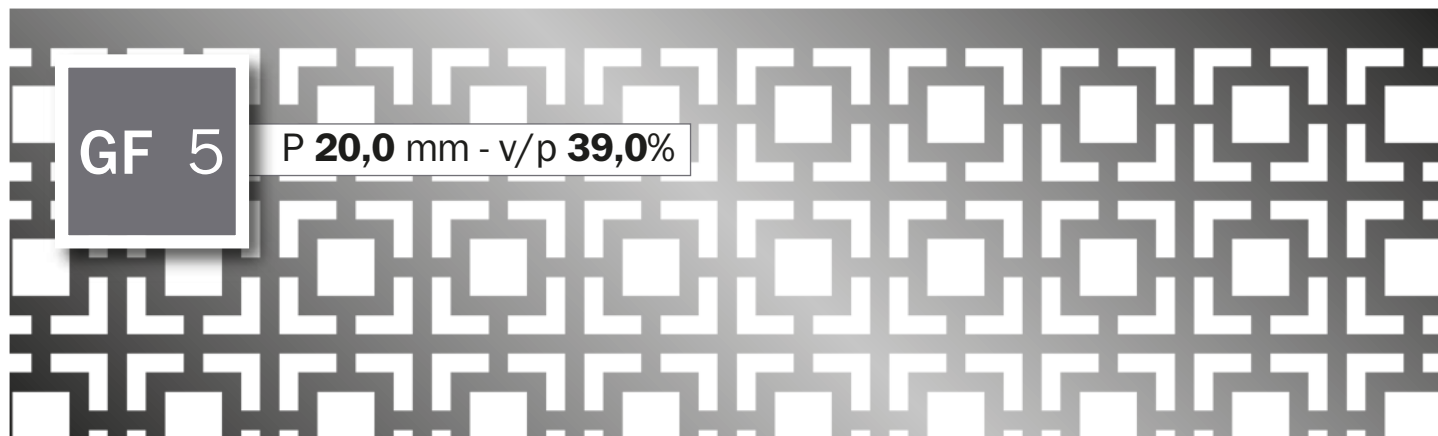

GF 5

P 20,0 mm - v/p 39,0%

MATERIALI	P	SPESSORE	FORMATO
ACCIAIO AL CARBONIO	mm	mm	1000 X 2000 Peso Kg/cad.
	20,0	1,0	8,60

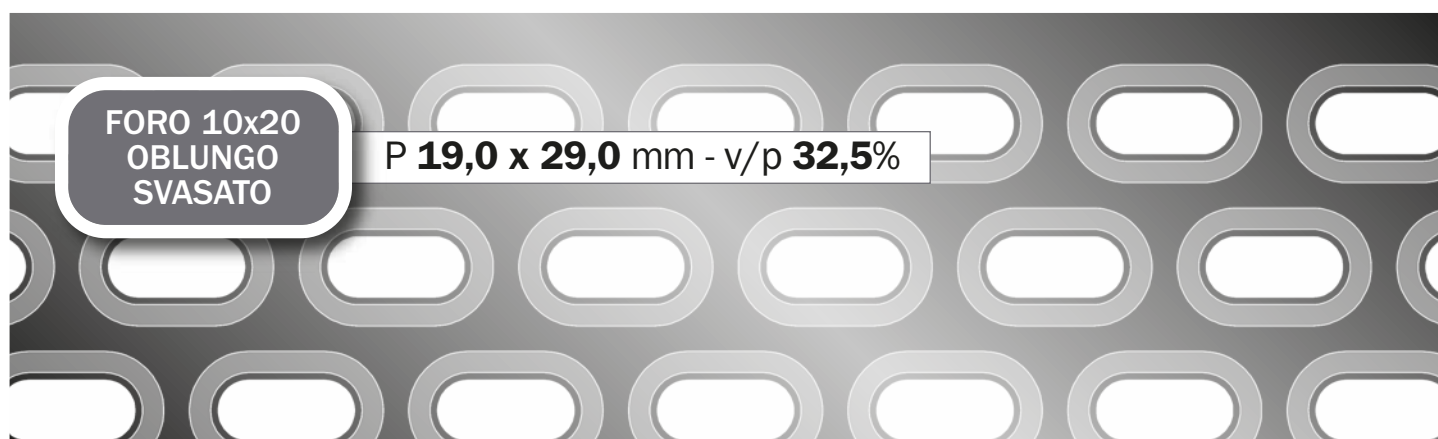
FORO 10x20  
OBLUNGO  
SVASATO

P 19,0 x 29,0 mm - v/p 32,5%

MATERIALI	P	SPESSORE	FORMATO
ACCIAIO AL CARBONIO	mm	mm	1000 X 2000 Peso Kg/cad.
	19,0 x 29,0	2,0	22,00

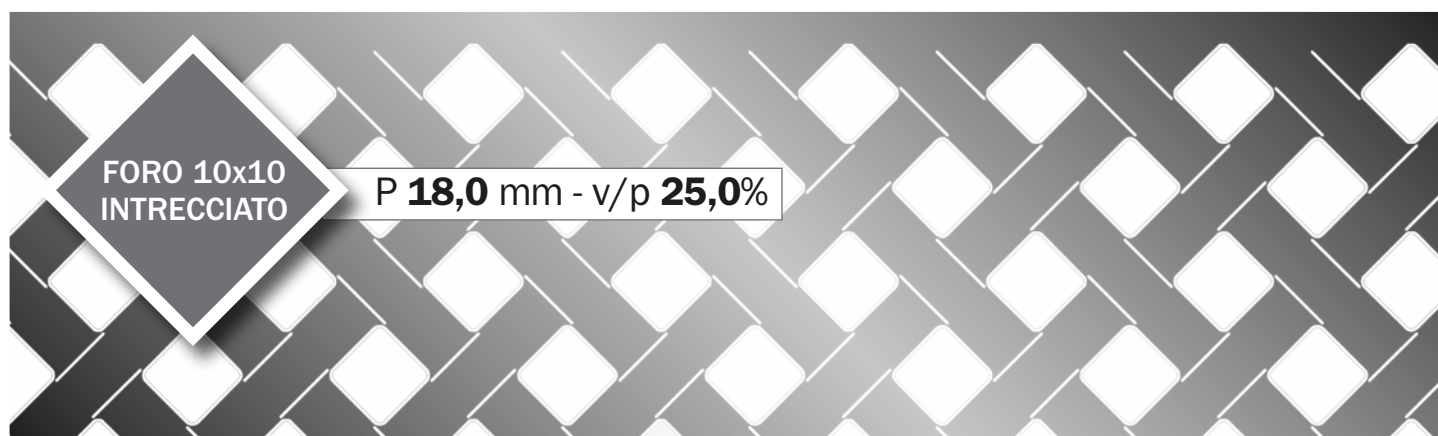
FORO 10x10  
INTRECCIATO

P 18,0 mm - v/p 25,0%

MATERIALI	P	SPESSORE	FORMATO
ACCIAIO AL CARBONIO	mm	mm	1000 X 2000 Peso Kg/cad.
	18,0	1,0	10,00

# TABELLA SINOTTICA LAMIERE FORATE SUDDIVISE PER MATERIALE

Per maggiore comodità di ricerca tra i vari materiali disponibili, le lamiere forate sono elencate secondo la sequenza indicata:

**Acciaio al carbonio**

**Acciaio al carbonio Sendzimir**

**Acciaio INOX AISI 304**

**Acciaio INOX AISI 316**

**Alluminio**



## LAMIERE FORATE TONDE - ACCIAIO AL CARBONIO

CODICE	Ø	V/P	SPESORE	PESO	FORMATO	SPESORE	PESO	FORMATO	SPESORE	PESO	FORMATO
	mm	mm	%	mm	Kg/cad.	mm	mm	Kg/cad.	mm	mm	Kg/cad. mm
R 1	1,0	22,7	1,0	12,10	1000 x 2000						
R 1,5	1,5	22,7	1,0	12,10	1000 x 2000						
	1,5	22,7	1,0	18,00	1000 x 2000						
R 2	2,0	29,6	1,0	11,00	1000 x 2000	1,0	17,00	1250 x 2500	1,0	24,90	1500 x 3000
	2,0	29,6	1,5	16,60	1000 x 2000	1,5	26,00	1250 x 2500	1,5	41,00	1500 x 3000
	2,0	29,6	2,0	24,30	1000 x 2000	2,0	38,00	1250 x 2500	2,0	54,60	1500 x 3000
R 2,5	2,0	35,4	1,0	10,20	1000 x 2000						
	2,0	35,4	1,5	15,30	1000 x 2000						
	2,0	35,4	2,0	20,30	1000 x 2000						
R 3	3,0	32,6	0,8	8,80	1000 x 2000						
	3,0	32,6	1,0	10,60	1000 x 2000	1,0	16,50	1250 x 2500	1,0	24,30	1500 x 3000
	3,0	32,6	1,5	15,90	1000 x 2000	1,5	24,80	1250 x 2500	1,5	35,70	1500 x 3000
	3,0	32,6	2,0	21,20	1000 x 2000	2,0	33,00	1250 x 2500	2,0	48,00	1500 x 3000
	3,0	32,6	3,0	31,70	1000 x 2000	3,0	49,60	1250 x 2500	3,0	71,00	1500 x 3000
R 4	4,0	40,3	0,8	7,50	1000 x 2000						
	4,0	40,3	1,0	9,40	1000 x 2000	1,0	14,60	1250 x 2500	1,0	21,50	1500 x 3000
	4,0	40,3	1,5	14,00	1000 x 2000	1,5	22,00	1250 x 2500	1,5	32,00	1500 x 3000
	4,0	40,3	2,0	18,70	1000 x 2000	2,0	29,30	1250 x 2500	2,0	42,10	1500 x 3000
	4,0	40,3	3,0	33,20	1000 x 2000	3,0	51,80	1250 x 2500	3,0	74,60	1500 x 3000
R 5	5,0	35,4	0,8	8,10	1000 x 2000						
	5,0	35,4	1,0	10,20	1000 x 2000	1,0	15,80	1250 x 2500	1,0	23,30	1500 x 3000
	5,0	35,4	1,5	15,30	1000 x 2000	1,5	23,80	1250 x 2500	1,5	34,50	1500 x 3000
	5,0	35,4	2,0	20,30	1000 x 2000	2,0	31,70	1250 x 2500	2,0	45,60	1500 x 3000
	5,0	35,4	3,0	30,50	1000 x 2000	3,0	47,50	1250 x 2500	3,0	68,50	1500 x 3000
	5,0	35,4	4,0	49,50	1000 x 2000						
	5,0	35,4	5,0	61,90	1000 x 2000						
R 6	6,0	40,3	0,8	7,50	1000 x 2000						
	6,0	40,3	1,0	9,40	1000 x 2000	1,0	14,60	1250 x 2500	1,0	21,50	1500 x 3000
	6,0	40,3	1,5	14,00	1000 x 2000	1,5	19,80	1250 x 2500	1,5	29,30	1500 x 3000
	6,0	40,3	2,0	18,80	1000 x 2000	2,0	29,30	1250 x 2500	2,0	42,00	1500 x 3000
	6,0	40,3	3,0	28,20	1000 x 2000	3,0	44,80	1250 x 2500	3,0	63,90	1500 x 3000
	6,0	40,3	4,0	43,10	1000 x 2000						
	6,0	40,3	5,0	53,90	1000 x 2000						
R 8	8,0	40,3	0,8	7,50	1000 x 2000						
	8,0	40,3	1,0	9,40	1000 x 2000	1,0	14,60	1250 x 2500	1,0	21,50	1500 x 3000
	8,0	40,3	1,5	14,00	1000 x 2000	1,5	22,00	1250 x 2500	1,5	31,60	1500 x 3000
	8,0	40,3	2,0	18,80	1000 x 2000	2,0	29,30	1250 x 2500	2,0	42,20	1500 x 3000
	8,0	40,3	3,0	28,20	1000 x 2000	3,0	43,90	1250 x 2500	3,0	63,30	1500 x 3000
	8,0	40,3	4,0	38,20	1000 x 2000						
	8,0	40,3	5,0	47,80	1000 x 2000						

CODICE	Ø	V/P	SPESORE	PESO	FORMATO	SPESORE	PESO	FORMATO	SPESORE	PESO	FORMATO
	mm	mm	%	mm	Kg/cad.	mm	mm	Kg/cad.	mm	mm	Kg/cad. mm
<b>R 10</b>	10,0	40,3	0,8	7,50	1000 x 2000						
	10,0	40,3	1,0	9,40	1000 x 2000	1,0	14,60	1250 x 2500	1,0	21,50	1500 x 3000
	10,0	40,3	1,5	14,00	1000 x 2000	1,5	22,00	1250 x 2500	2,0	31,60	1500 x 3000
	10,0	40,3	2,0	18,80	1000 x 2000	2,0	29,30	1250 x 2500	2,0	42,20	1500 x 3000
	10,0	40,3	3,0	28,20	1000 x 2000	3,0	44,00	1250 x 2500	3,0	63,30	1500 x 3000
	10,0	40,3	4,0	38,20	1000 x 2000						
	10,0	40,3	5,0	47,80	1000 x 2000						
<b>R 12</b>	12,0	40,3	1,0	9,40	1000 x 2000	1,0	14,60	1250 x 2500	1,0	21,10	1500 x 3000
	12,0	40,3	1,5	14,00	1000 x 2000	1,5	22,00	1250 x 2500	1,5	31,60	1500 x 3000
	12,0	40,3	2,0	19,30	1000 x 2000	2,0	29,30	1250 x 2500	2,0	42,20	1500 x 3000
	12,0	40,3	3,0	28,10	1000 x 2000	3,0	44,00	1250 x 2500	2,0	63,00	1500 x 3000
<b>R 15</b>	15,0	42,1	1,5	11,00	1000 x 2000	1,5	20,00	1250 x 2500	1,5	23,80	1500 x 3000
	15,0	42,1	2,0	18,20	1000 x 2000	2,0	28,30	1250 x 2500	2,0	33,20	1500 x 3000
	15,0	42,1	3,0	27,00	1000 x 2000	3,0	36,40	1250 x 2500	3,0	62,00	1500 x 3000
<b>R 20</b>	20,0	40,3	1,5	12,00	1000 x 2000	1,5	19,00	1250 x 2500	1,5	26,70	1500 x 3000
	20,0	40,3	2,0	17,90	1000 x 2000	2,0	25,00	1250 x 2500	2,0	35,60	1500 x 3000
	20,0	40,3	3,0	28,10	1000 x 2000	3,0	38,00	1250 x 2500	3,0	56,20	1500 x 3000
<b>R 25</b>	25,0	46,2	1,5		1000 x 2000	1,5	19,00	1250 x 2500	1,5	31,00	1500 x 3000
	25,0	46,2	2,0	14,00	1000 x 2000	2,0	26,40	1250 x 2500	2,0	38,00	1500 x 3000
	25,0	46,2	3,0		1000 x 2000	3,0	40,50	1250 x 2500	3,0	59,00	1500 x 3000



## LAMIERE FORATE TONDE - ACCIAIO AL CARBONIO SENDZIMIR

CODICE	Ø	V/P	SPESORE	PESO	FORMATO	SPESORE	PESO	FORMATO	SPESORE	PESO	FORMATO
	mm	mm	%	mm	Kg/cad.	mm	mm	Kg/cad.	mm	mm	Kg/cad. mm
<b>R 3</b>	3,0	32,6	0,8	8,80	1000 x 2000						
	3,0	32,6	1,0	10,60	1000 x 2000	1,0	16,50	1250 x 2500	1,0	24,30	1500 x 3000
	3,0	32,6	1,5	15,90	1000 x 2000	1,5	24,80	1250 x 2500	1,5	35,70	1500 x 3000
	3,0	32,6	2,0	21,20	1000 x 2000	2,0	33,00	1250 x 2500	2,0	48,00	1500 x 3000
	3,0	32,6	3,0	32,00	1000 x 2000	3,0	49,60	1250 x 2500	3,0	71,00	1500 x 3000
<b>R 4</b>	4,0	40,3	0,8	7,50	1000 x 2000						
	4,0	40,3	1,0	9,40	1000 x 2000	1,0	14,60	1250 x 2500	1,0	21,50	1500 x 3000
	4,0	40,3	1,5	14,00	1000 x 2000	1,5	22,00	1250 x 2500	2,0	32,20	1500 x 3000
	4,0	40,3	2,0	18,70	1000 x 2000	2,0	29,30	1250 x 2500	2,0	42,10	1500 x 3000
	4,0	40,3	3,0	33,20	1000 x 2000	3,0	51,80	1250 x 2500	3,0	74,60	1500 x 3000
<b>R 5</b>	5,0	35,4	0,8	8,10	1000 x 2000						
	5,0	35,4	1,0	10,20	1000 x 2000	1,0	15,80	1250 x 2500	1,0	23,30	1500 x 3000
	5,0	35,4	1,5	15,30	1000 x 2000	1,5	23,80	1250 x 2500	2,0	34,50	1500 x 3000
	5,0	35,4	2,0	20,30	1000 x 2000	2,0	31,70	1250 x 2500	2,0	45,60	1500 x 3000
	5,0	35,4	3,0	30,40	1000 x 2000	3,0	47,50	1250 x 2500	3,0	68,50	1500 x 3000
<b>R 6</b>	6,0	40,3	0,8	7,50	1000 x 2000						
	6,0	40,3	1,0	9,40	1000 x 2000	1,0	14,60	1250 x 2500	1,0	21,50	1500 x 3000
	6,0	40,3	1,5	14,00	1000 x 2000	1,5	19,80	1250 x 2500	2,0	29,30	1500 x 3000
	6,0	40,3	2,0	18,80	1000 x 2000	2,0	29,30	1250 x 2500	2,0	42,00	1500 x 3000
	6,0	40,3	3,0	28,10	1000 x 2000	3,0	44,80	1250 x 2500	3,0	63,30	1500 x 3000
<b>R 8</b>	8,0	40,3	0,8	7,50	1000 x 2000						
	8,0	40,3	1,0	9,40	1000 x 2000	1,0	14,60	1250 x 2500	1,0	21,50	1500 x 3000
	8,0	40,3	1,5	14,00	1000 x 2000	1,5	22,00	1250 x 2500	2,0	31,60	1500 x 3000
	8,0	40,3	2,0	18,80	1000 x 2000	2,0	29,30	1250 x 2500	2,0	42,20	1500 x 3000
	8,0	40,3	3,0	28,10	1000 x 2000	3,0	44,00	1250 x 2500	3,0	63,30	1500 x 3000
<b>R 10</b>	10,0	40,3	0,8	7,50	1000 x 2000						
	10,0	40,3	1,0	9,40	1000 x 2000	1,0	14,60	1250 x 2500	1,0	21,50	1500 x 3000
	10,0	40,3	1,5	14,00	1000 x 2000	1,5	22,00	1250 x 2500	2,0	31,60	1500 x 3000
	10,0	40,3	2,0	18,80	1000 x 2000	2,0	29,30	1250 x 2500	2,0	42,20	1500 x 3000
	10,0	40,3	3,0	28,10	1000 x 2000	3,0	44,00	1250 x 2500	3,0	63,30	1500 x 3000



## LAMIERE FORATE TONDE - ACCIAIO INOX AISI 304

CODICE	Ø	V/P	SPESSORE	PESO	FORMATO	SPESSORE	PESO	FORMATO	SPESSORE	PESO	FORMATO
	mm	mm	%	mm	Kg/cad.	mm	mm	Kg/cad.	mm	mm	Kg/cad. mm
<b>R 1</b>	1,0	22,7	1,0	12,10	1000 x 2000						
<b>R 1,5</b>	1,5	22,7	1,0	12,10	1000 x 2000						
	1,5	22,7	1,0	18,00	1000 x 2000						
<b>R 2</b>	2,0	29,6	1,0	11,00	1000 x 2000						
	2,0	29,6	1,5	16,60	1000 x 2000	1,5	29,00	1250 x 2500	1,5	41,80	1500 x 3000
	2,0	29,6	2,0	24,30	1000 x 2000						
<b>R 3</b>	3,0	32,6	0,8	8,60	1000 x 2000						
	3,0	32,6	1,0	10,60	1000 x 2000						
	3,0	32,6	1,5	15,90	1000 x 2000	1,5	24,80	1250 x 2500	1,5	35,70	1500 x 3000
	3,0	32,6	2,0	21,20	1000 x 2000	2,0	33,40	1250 x 2500	2,0	48,50	1500 x 3000
<b>R 4</b>	4,0	40,3	0,8	7,60	1000 x 2000						
	4,0	40,3	1,0	9,40	1000 x 2000						
	4,0	40,3	1,5	14,00	1000 x 2000	1,5	26,40	1250 x 2500	1,5	32,30	1500 x 3000
	4,0	40,3	2,0	18,70	1000 x 2000	2,0	35,20	1250 x 2500	2,0	51,00	1500 x 3000
<b>R 5</b>	5,0	35,4	0,8	8,30	1000 x 2000						
	5,0	35,4	1,0	10,20	1000 x 2000						
	5,0	35,4	1,5	15,30	1000 x 2000	1,5	23,80	1250 x 2500	1,5	34,50	1500 x 3000
	5,0	35,4	2,0	20,30	1000 x 2000	2,0	32,30	1250 x 2500	2,0	46,50	1500 x 3000
	5,0	35,4	3,0	30,50	1000 x 2000						
<b>R 6</b>	6,0	40,3	0,8	7,60	1000 x 2000						
	6,0	40,3	1,0	9,40	1000 x 2000						
	6,0	40,3	1,5	14,00	1000 x 2000	1,5	22,40	1250 x 2500	1,5	32,20	1500 x 3000
	6,0	40,3	2,0	18,80	1000 x 2000	2,0	28,50	1250 x 2500	2,0	43,00	1500 x 3000
	6,0	40,3	3,0	28,20	1000 x 2000						
<b>R 8</b>	8,0	40,3	0,8	7,60	1000 x 2000						
	8,0	40,3	1,0	9,40	1000 x 2000						
	8,0	40,3	1,5	14,00	1000 x 2000	1,5	22,00	1250 x 2500	1,5	31,60	1500 x 3000
	8,0	40,3	2,0	18,80	1000 x 2000	2,0	29,90	1250 x 2500	2,0	43,00	1500 x 3000
	8,0	40,3	3,0	28,20	1000 x 2000						
<b>R 10</b>	10,0	40,3	0,8	7,60	1000 x 2000						
	10,0	40,3	1,0	9,40	1000 x 2000						
	10,0	40,3	1,5	14,00	1000 x 2000	1,5	22,00	1250 x 2500	1,5	31,60	1500 x 3000
	10,0	40,3	2,0	18,80	1000 x 2000	2,0	29,90	1250 x 2500	2,0	43,00	1500 x 3000
	10,0	40,3	3,0	28,20	1000 x 2000						



## LAMIERE FORATE TONDE - ACCIAIO INOX AISI 316

CODICE	Ø	V/P	SPESSORE	PESO	FORMATO	SPESSORE	PESO	FORMATO	SPESSORE	PESO	FORMATO
	mm	mm	%	mm	Kg/cad.	mm	mm	Kg/cad.	mm	mm	Kg/cad. mm
<b>R 3</b>	3,0	32,6	1,0	10,60	1000 x 2000						
	3,0	32,6	1,5	16,20	1000 x 2000	1,5	25,30	1250 x 2500	1,5	36,40	1500 x 3000
	3,0	32,6	2,0	21,60	1000 x 2000						
<b>R 4</b>	4,0	40,3	1,0	9,40	1000 x 2000						
	4,0	40,3	1,5	16,90	1000 x 2000	1,5	22,40	1250 x 2500	1,5	32,30	1500 x 3000
	4,0	40,3	2,0	19,10	1000 x 2000						
<b>R 5</b>	5,0	35,4	1,0	10,40	1000 x 2000						
	5,0	35,4	1,5	15,30	1000 x 2000	1,5	24,20	1250 x 2500	1,5	34,90	1500 x 3000
	5,0	35,4	2,0	20,30	1000 x 2000						
<b>R 6</b>	6,0	40,3	1,0	9,50	1000 x 2000						
	6,0	40,3	1,5	14,30	1000 x 2000	1,5	22,40	1250 x 2500	1,5	32,20	1500 x 3000
	6,0	40,3	2,0	18,80	1000 x 2000						
<b>R 8</b>	8,0	40,3	1,0	9,60	1000 x 2000						
	8,0	40,3	1,5	14,30	1000 x 2000	1,5	22,40	1250 x 2500	1,5	32,20	1500 x 3000
	8,0	40,3	2,0	19,10	1000 x 2000						
<b>R 10</b>	10,0	40,3	1,0	9,60	1000 x 2000						
	10,0	40,3	1,5	14,30	1000 x 2000	1,5	22,40	1250 x 2500	1,5	32,30	1500 x 3000
	10,0	40,3	2,0	19,10	1000 x 2000						





## LAMIERE FORATE TONDE - ALLUMINIO

CODICE	Ø	V/P	SPESSORE	PESO	FORMATO	SPESSORE	PESO	FORMATO	SPESSORE	PESO	FORMATO
	mm	mm	%	mm	Kg/cad.	mm	mm	Kg/cad.	mm	mm	Kg/cad. mm
<b>R 3</b>	3,0	32,6	1,0	3,60	1000 x 2000	1,0	5,69	1250 x 2500	1,0	8,20	1500 x 3000
	3,0	32,6	1,5	5,60	1000 x 2000	1,5	8,40	1250 x 2500	1,5	12,30	1500 x 3000
	3,0	32,6	2,0	7,30	1000 x 2000	2,0	11,40	1250 x 2500	2,0	16,40	1500 x 3000
	3,0	32,6	3,0	10,90	1000 x 2000						
<b>R 4</b>	4,0	40,3	1,0	3,10	1000 x 2000	1,0	5,00	1250 x 2500	1,0	7,20	1500 x 3000
	4,0	40,3	1,5	5,00	1000 x 2000	1,5	7,60	1250 x 2500	1,5	10,88	1500 x 3000
	4,0	40,3	2,0	6,50	1000 x 2000	2,0	10,10	1250 x 2500	2,0	14,50	1500 x 3000
	4,0	40,3	3,0	9,70	1000 x 2000						
<b>R 5</b>	5,0	35,4	1,0	3,50	1000 x 2000	1,0	5,50	1250 x 2500	1,0	7,90	1500 x 3000
	5,0	35,4	1,5	4,40	1000 x 2000	1,5	8,20	1250 x 2500	1,5	11,80	1500 x 3000
	5,0	35,4	2,0	6,92	1000 x 2000	2,0	10,90	1250 x 2500	2,0	15,70	1500 x 3000
	5,0	35,4	3,0	10,50	1000 x 2000						
<b>R 6</b>	6,0	40,3	1,0	3,20	1000 x 2000	1,0	5,00	1250 x 2500	1,0	7,20	1500 x 3000
	6,0	40,3	1,5	5,00	1000 x 2000	1,5	7,60	1250 x 2500	1,5	11,00	1500 x 3000
	6,0	40,3	2,0	6,50	1000 x 2000	2,0	10,00	1250 x 2500	2,0	14,50	1500 x 3000
	6,0	40,3	3,0	9,70	1000 x 2000						
<b>R 8</b>	8,0	40,3	1,0	3,20	1000 x 2000	1,0	5,00	1250 x 2500	1,0	7,30	1500 x 3000
	8,0	40,3	1,5	5,00	1000 x 2000	1,5	7,60	1250 x 2500	1,5	10,90	1500 x 3000
	8,0	40,3	2,0	6,50	1000 x 2000	2,0	10,70	1250 x 2500	2,0	14,50	1500 x 3000
	8,0	40,3	3,0	9,70	1000 x 2000						
<b>R 10</b>	10,0	40,3	1,0	3,10	1000 x 2000	1,0	5,00	1250 x 2500	1,0	7,30	1500 x 3000
	10,0	40,3	1,5	5,00	1000 x 2000	1,5	7,60	1250 x 2500	1,5	10,90	1500 x 3000
	10,0	40,3	2,0	6,30	1000 x 2000	2,0	10,10	1250 x 2500	2,0	14,50	1500 x 3000
	10,0	40,3	3,0	9,70	1000 x 2000						



## LAMIERE FORATE QUADRE - ACCIAIO AL CARBONIO

CODICE	C (W)	U	V/P	SPESSORE	PESO	FORMATO	SPESSORE	PESO	FORMATO	SPESSORE	PESO	FORMATO
	mm	mm	%	mm	Kg/cad.	mm	mm	Kg/cad.	mm	mm	Kg/cad.	mm
<b>C 5 - U 7</b>	5,0	7,0	51,0	1,0	7,70	1000 x 2000						
	5,0	7,0	51,0	1,5	11,60	1000 x 2000						
<b>C 8 - U 10</b>	8,0	10,0	64,0	1,0	5,70	1000 x 2000						
	8,0	10,0	64,0	1,5	8,50	1000 x 2000						
<b>C 8 - U 12</b>	8,0	12,0	44,4	1,0	8,80	1000 x 2000	1,0	13,60	1250 x 2500	1,0	19,60	1500 x 3000
	8,0	12,0	44,4	1,5	13,00	1000 x 2000	1,5	20,50	1250 x 2500	1,5	29,50	1500 x 3000
	8,0	12,0	44,4	2,0	17,50	1000 x 2000	2,0	27,30	1250 x 2500	2,0	39,00	1500 x 3000
<b>C 10 - U 12</b>	10,0	12,0	69,5	1,0	4,80	1000 x 2000						
	10,0	12,0	69,5	1,5	7,10	1000 x 2000						
<b>C 10 - U 15</b>	10,0	15,0	44,4	0,8	7,00	1000 x 2000						
	10,0	15,0	44,4	1,0	8,70	1000 x 2000	1,0	13,60	1250 x 2500	1,5	20,00	1500 x 3000
	10,0	15,0	44,4	1,5	13,00	1000 x 2000	1,5	20,40	1250 x 2500	2,0	29,50	1500 x 3000
	10,0	15,0	44,4	2,0	17,50	1000 x 2000	2,0	27,30	1250 x 2500	2,0	39,00	1500 x 3000
	10,0	15,0	44,4	3,0	26,20	1000 x 2000	3,0	42,00	1250 x 2500	2,0	59,00	1500 x 3000



## LAMIERE FORATE QUADRE - ACCIAIO AL CARBONIO SENDZIMIR

CODICE	C (W)	U	V/P	SPESSORE	PESO	FORMATO	SPESSORE	PESO	FORMATO	SPESSORE	PESO	FORMATO
	mm	mm	%	mm	Kg/cad.	mm	mm	Kg/cad.	mm	mm	Kg/cad.	mm
<b>C 5 - U 7</b>	5,0	7,0	51,0	1,5	11,60	1000 x 2000						
<b>C 8 - U 12</b>	8,0	12,0	44,5				1,0	13,60	1250 x 2500	1,0	20,00	1500 x 3000
	8,0	12,0	44,5	1,5	13,00	1000 x 2000	1,5	20,40	1250 x 2500	1,5	29,50	1500 x 3000
	8,0	12,0	44,5				2,0	27,30	1250 x 2500	2,0	39,00	1500 x 3000
<b>C 10 - U 15</b>	10,0	15,0	44,4	0,8	7,00	1000 x 2000						
	10,0	15,0	44,4	1,0	8,70	1000 x 2000	1,0	13,60	1250 x 2500	1,5	20,00	1500 x 3000
	10,0	15,0	44,4	1,5	13,00	1000 x 2000	1,5	20,40	1250 x 2500	2,0	29,50	1500 x 3000
	10,0	15,0	44,4	2,0	17,50	1000 x 2000	2,0	27,30	1250 x 2500	2,0	39,00	1500 x 3000
	10,0	15,0	44,4	3,0	26,20	1000 x 2000	3,0	42,00	1250 x 2500	2,0	59,00	1500 x 3000



## LAMIERE FORATE QUADRE - ACCIAIO INOX AISI 304

CODICE	C (W)	U	V/P	SPESSORE	PESO	FORMATO	SPESSORE	PESO	FORMATO	SPESSORE	PESO	FORMATO
	mm	mm	%	mm	Kg/cad.	mm	mm	Kg/cad.	mm	mm	Kg/cad.	mm
<b>C 5 - U 7</b>	5,0	7,0	51,0	1,0	7,70	1000 x 2000						
<b>C 10 - U 15</b>	10,0	15,0	44,4	0,8	7,00	1000 x 2000						
	10,0	15,0	44,4	1,0	8,70	1000 x 2000	1,0	13,90	1250 x 2500	1,0	20,00	1500 x 3000
	10,0	15,0	44,4	1,5	13,00	1000 x 2000	1,5	20,40	1250 x 2500	1,5	29,50	1500 x 3000
	10,0	15,0	44,4	2,0	17,50	1000 x 2000	2,0	29,90	1250 x 2500	2,0	40,00	1500 x 3000



## LAMIERE FORATE QUADRE - ACCIAIO INOX AISI 316

CODICE	C (W)	U	V/P	SPESSORE	PESO	FORMATO	SPESSORE	PESO	FORMATO	SPESSORE	PESO	FORMATO
	mm	mm	%	mm	Kg/cad.	mm	mm	Kg/cad.	mm	mm	Kg/cad.	mm
<b>C 10 - U 15</b>	10,0	15,0	44,4	1,0	8,90	1000 x 2000						
	10,0	15,0	44,4	1,5	13,30	1000 x 2000						
	10,0	15,0	44,4	2,0	17,80	1000 x 2000						



## LAMIERE FORATE QUADRE - ALLUMINIO

CODICE	C (W)	U	V/P	SPESSORE	PESO	FORMATO	SPESSORE	PESO	FORMATO	SPESSORE	PESO	FORMATO
	mm	mm	%	mm	Kg/cad.	mm	mm	Kg/cad.	mm	mm	Kg/cad.	mm
<b>C 5 - U 7</b>	5,0	7,0	51,0	1,0	2,60	1000 x 2000						
<b>C 10 - U 15</b>	10,0	15,0	44,4	1,0	3,00	1000 x 2000	1,0	4,70	1250 x 2500	1,0	6,80	1500 x 3000
	10,0	15,0	44,4	1,5	4,60	1000 x 2000	1,5	7,00	1250 x 2500	1,5	10,10	1500 x 3000
	10,0	15,0	44,4	2,0	6,00	1000 x 2000	2,0	9,10	1250 x 2500	2,0	13,50	1500 x 3000
	10,0	15,0	44,4	3,0	9,00	1000 x 2000						



## LAMIERE FORATE FANTASIA - ACCIAIO AL CARBONIO

CODICE	P	V/P	SPESSORE	PESO	FORMATO
	mm	%	mm	Kg/cad.	mm
<b>GF17 - P9</b>	9,0	42,0	1,0	8,80	1000 x 2000
<b>GF20 - P14</b>	14,0	40,0	1,0	11,30	1000 x 2000
<b>GF11 - P16</b>	16,0	32,0	1,0	7,00	1000 x 2000
<b>GF5 - P20</b>	20,0	39,0	1,0	8,60	1000 x 2000
<b>10x20 SVASATO</b>	19,0x29,0	32,5	2,0	22,00	1000 x 2000
<b>10x10 INTRECCIATO</b>	18,0	25,0	1,0	10,00	1000 x 2000

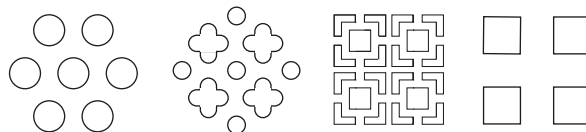

I testi e le immagini pubblicati nel presente catalogo sono di proprietà esclusiva della Società e, pertanto, ne è vietata la riproduzione e l'utilizzo senza il consenso scritto della stessa. La Società si riserva il diritto di modificare i prodotti illustrati senza preavviso. I dati tecnici e le descrizioni riportate sono stati accuratamente controllati: si declina ogni responsabilità per errori o omissioni.





**Fils S.p.A.**  
**Fabbrica Italiana Lamiera Stirate**  
Società unipersonale soggetta a direzione  
e coordinamento di L HOLDING S.r.l.

Via Crocette, 21 (Zona Ind. 1)  
24066 Pedrengo (Bergamo) Italy  
Tel. +39 035 661 471  
fils@fils.it

**LAMIERE STIRATE**  
**LAMIERE FORATE**  
**RETI ONDULATE**  
**RETI TESSUTE**  
**GRIGLIATI**  
**GRADINI E PIANEROTTOLI**  
**RECINZIONI**